

# LINEAR LIGHT SERIES GEN 3

140lm/w

Technology and innovation

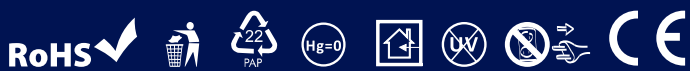
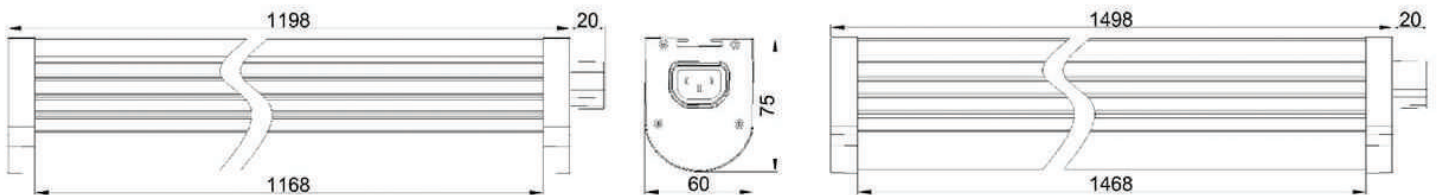
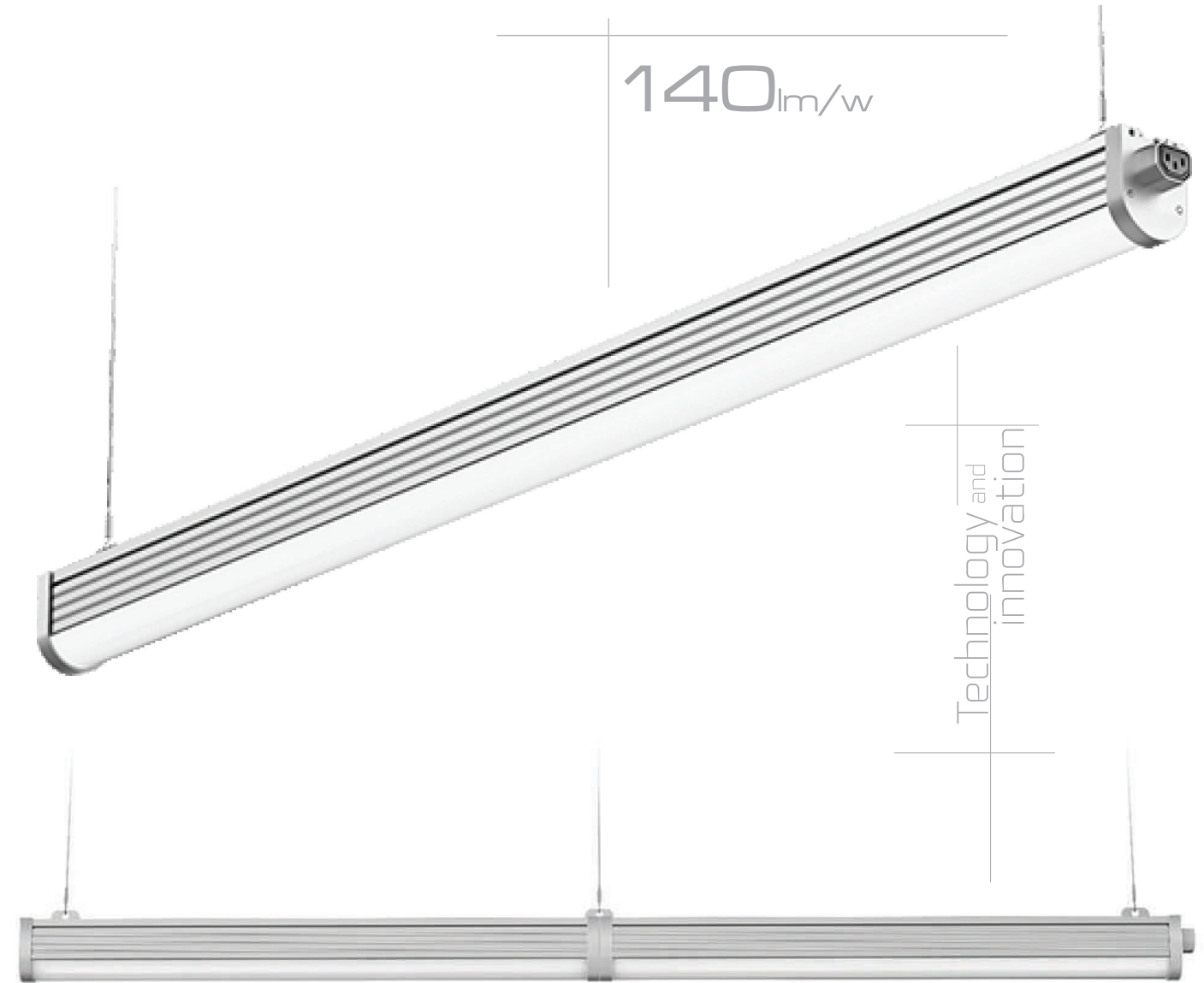

NEW GENERATION  
LED

Technology and innovation

[www.isrlight.com](http://www.isrlight.com)

# LINEAR LIGHT SERIES GEN 3

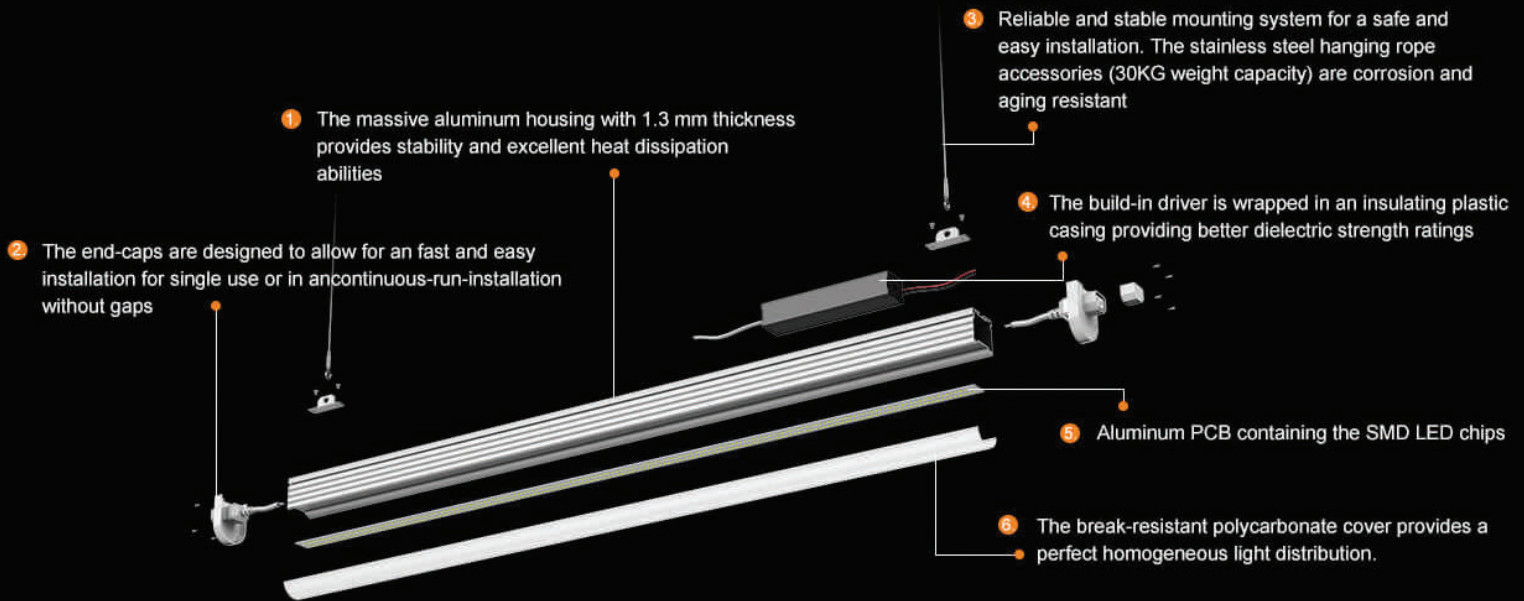

40W

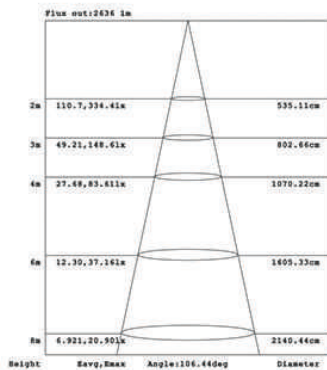
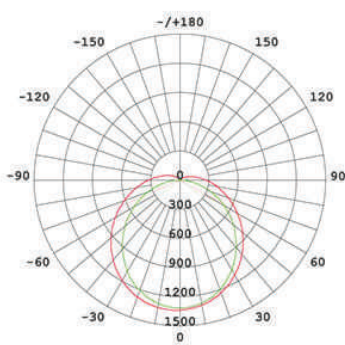

140lm/w

60W

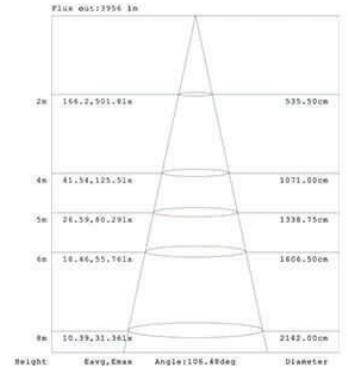
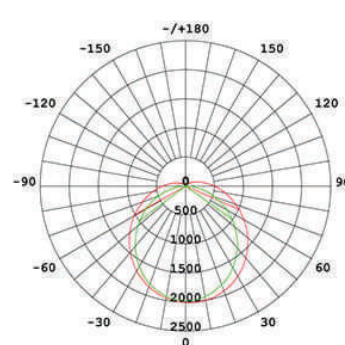

130lm/w

Model	Moc	Lm	Barwa	Kąt Świecenia	V	Sprawność	CRI	IP	Waga	Rozmiar	Szybkość	Trwałość	ON/OFF	Temp. Pracy
LL-G3-40/12+	40W	5600	3000K/4000K 5000K/6000K	120°	100-277V AC 50/60Hz	0,92	>80	54	2,2	1350x280x170	95%<1s	50000	≥100000	-30/+50
LL-G3-60/12+	60W	8400	3000K/4000K 5000K/6000K	120°	100-277V AC 50/60Hz	0,92	>80	54	2,2	1350x280x170	95%<1s	50000	≥100000	-30/+50
LL-G3-60/15+	60W	8400	3000K/4000K 5000K/6000K	120°	100-277V AC 50/60Hz	0,92	>80	54	3	1650x280x170	95%<1s	50000	≥100000	-30/+50

Model	Moc	Lm	Barwa	Kąt Świecenia	V	Sprawność	CRI	IP	Waga	Rozmiar	Szybkość	Trwałość	ON/OFF	Temp. Pracy
LL-G3-60/12	60W	7800	3000K/4000K 5000K/6000K	120°	100-277V AC 50/60Hz	0,92	>80	54	2,2	1350x280x170	95%<1s	50000	≥100000	-30/+50
LL-G3-60/15	60W	7800	3000K/4000K 5000K/6000K	120°	100-277V AC 50/60Hz	0,92	>80	54	3	1650x280x170	95%<1s	50000	≥100000	-30/+50



NEW GENERATION LED

Technology and innovation

www.isrlight.com